



Document Title:  
**Socket Y Clevis 50,000 lbs**

Document Type:  
**Specification**

Engineering Type  
**Material Specification**

Document No.:  
**4752.321**

Department:

Version:  
01

Effective Date:  
Dec 19, 2024

**Transmission  
Engineering**

**Shared document with: N/A**

**Author**

Guillermo J. Nieves Díaz  
Technical Specialist 1, Transmission Lines Engineering  
Design & Standards

  
Guillermo Nieves (Dec 6, 2024 16:17 AST)

**Reviewer 1**

Leonardo Montes Sánchez  
Engineer 2, Transmission Lines Engineering Design &  
Standards

  
Leonardo Montes Sanchez (Dec 9, 2024 15:54 AST)

**Reviewer 2**

Oscar Venegas  
Supervisor, Transmission Lines Engineering Design &  
Standards

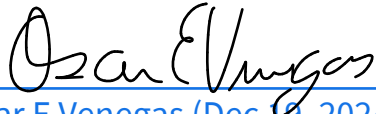
  
Oscar E Venegas (Dec 19, 2024 13:55 AST)

**Approver**

Yamil I. Rivera Hernández  
Section Manager, Transmission Lines Engineering  
Design

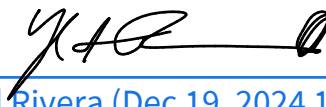
  
Yamil Rivera (Dec 19, 2024 13:57 AST)

**Management Approval (If apply)**

**Approver**

Name  
Position

Signature and Date

**Related/Referenced Documents**

Version	Date	Revision Comments
00	May 30, 2023	First Issue
01	Dec 19, 2024	Changed cover page and document to new format. Modified sections 4 and 7. Added a table of compliance and Proposal Information. Equal or approved equal to changed to Compatible with and was modified.

## **1. General**

### **1.1. Overview**

- 1.1.1. This is a general specification that covers the minimum requirements for a Socket Y Clevis 50,000 lbs to be used in the transmission system in Puerto Rico.
- 1.1.2. Further information will be provided by LUMA Energy at the time of order placement and will provide information on site conditions, quantity, and other requirements.
- 1.1.3. This document includes the general electrical and mechanical characteristics of the material.

## **2. Specific Name**

- 2.1. Socket Y Clevis 50,000 lbs.

## **3. Basic Use**

- 3.1. For attaching high capacity deadend conductor support assembly on overhead transmission lines that require heavy tensions.

## **4. Specific Requirements**

- 4.1. Samples shall be furnished to LUMA.
- 4.2. LUMA requires One (1) unit properly labeled for testing and analysis.
- 4.3. Descriptive and technical literature shall be supplied to LUMA.
- 4.4. They shall be required to show evidence of LUMA's approval of the equipment.

## **5. Acceptance Criteria**

- 5.1. Latest applicable codes, standards, and other regulations: ANSI/ASTM.

## **6. Description**

- 6.1. Socket Y Clevis shall be made with an ultimate strength of 50,000LBF minimum, as per ANSI Class 52-11.
- 6.2. Socket Y-Clevis shall fit ball and socket insulators ANSI classes 52-8 and 52-11 per ANSI Spec. C-29.2-71.
- 6.3. Body shall be galvanized ductile iron.
- 6.4. Hardware shall be galvanized steel.
- 6.5. Cotter Pin shall be stainless steel.
- 6.6. Shall be hot-dip galvanized in accordance with ANSI/ASTM A153.
- 6.7. Metric conversion as per latest ASTM.

**7. Markings and Packaging**

- 7.1. Containers/pallets or package shall be marked outside with LUMA'S purchase order number and code number.
- 7.2. Vendor shall prepare material and equipment for shipment in such manner as to facilitate handling and protection for damage.
- 7.3. All material should be packaged and marked in such a way that the receiving warehouse can readily identify and send in one (1) complete unit to a field location without opening crates or boxes to sort items and / or parts.
- 7.4. Pallet quantity: 576.

**8. Compatible with:**

- 8.1. Hubble catalog No. SYC50
- 8.2. MacLean Power Systems catalog No. SYCR-87
- 8.3. These models are an example of the equipment/material described in this document and do not represent a preference. LUMA will evaluate equally any model not listed here during any acquisition event.

**9. Proposal Information**

- 9.1. Submitted proposals must include:
  - a. Technical Information
  - b. Table of Compliance completed by the bidder with reference

**10. Inspection**

- 10.1. The acceptance of any material or equipment shall in no way relieve the vendor from his responsibility to meet all the requirements of this specification, and it shall not prevent subsequent rejection if such material is found to be defective later

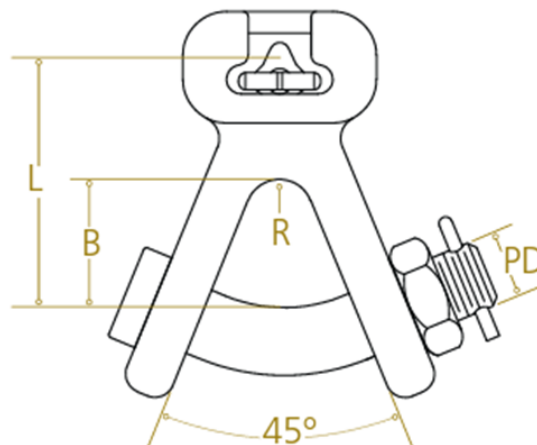
**11. Drawings**

**Table 1:** Dimensions

L Min.	B Min.	R Min.	PD
2 <sup>7</sup> / <sub>8</sub> "	1 <sup>5</sup> / <sub>8</sub> "	<sup>1</sup> / <sub>2</sub> "	<sup>7</sup> / <sub>8</sub> "

Warehouse ID	002-84815
--------------	-----------

— End of Specification —

## Appendix

Appendix 1. Table of Compliance

Line	Criteria	Description	Pass/Fail (P / F)	Comments
1	Specification	The Proponent complies with the corresponding specification document (4752.321)		
2	Industry Standards	The Proponent complies with the industry standards established in the specification document (ANSI, ASTM)		
3	Material	Socket Y Clevis 50,000 lbs. <ul style="list-style-type: none"> <li>• Shall be made with an ultimate strength of 50,000LBF minimum, as per ANSI Class 52-11.</li> <li>• Shall fit ball and socket insulators ANSI classes 52-8 and 52-11 per ANSI Spec. C-29.2-71.</li> <li>• Body shall be galvanized ductile iron.</li> <li>• Hardware shall be galvanized steel.</li> <li>• Cotter Pin shall be stainless steel.</li> <li>• Shall be hot-dip galvanized in accordance with ANSI/ASTM A153.</li> </ul>		
4	Dimensions	Complies with Table 1		
5	Requirements	<ul style="list-style-type: none"> <li>• Samples shall be furnished to LUMA.</li> <li>• Descriptive and technical literature shall be supplied to LUMA.</li> <li>• Required to be certified by external laboratories.</li> </ul>		











# 4752.321 Socket Y Clevis 50,000 lbs

Final Audit Report

2024-12-19

Created:	2024-12-06
By:	Guillermo Nieves (guillermoj.nievesdia@lumapr.com)
Status:	Signed
Transaction ID:	CBJCHBCAABAATHIIQiDpmA7DWnKTDnNpJrFPMjKlw_G7

## "4752.321 Socket Y Clevis 50,000 lbs" History

-  Document created by Guillermo Nieves (guillermoj.nievesdia@lumapr.com)  
2024-12-06 - 8:17:16 PM GMT
-  Document e-signed by Guillermo Nieves (guillermoj.nievesdia@lumapr.com)  
Signature Date: 2024-12-06 - 8:17:59 PM GMT - Time Source: server
-  Document emailed to Leonardo Montes Sanchez (leonardo.montessanch@lumapr.com) for signature  
2024-12-06 - 8:18:01 PM GMT
-  Document e-signed by Leonardo Montes Sanchez (leonardo.montessanch@lumapr.com)  
Signature Date: 2024-12-09 - 7:54:33 PM GMT - Time Source: server- Signature captured from device with phone number XXXXXXX5488
-  Document emailed to Oscar Venegas (oscar.venegas@lumapr.com) for signature  
2024-12-09 - 7:54:35 PM GMT
-  Signer Oscar Venegas (oscar.venegas@lumapr.com) entered name at signing as Oscar E Venegas  
2024-12-19 - 5:55:39 PM GMT
-  Document e-signed by Oscar E Venegas (oscar.venegas@lumapr.com)  
Signature Date: 2024-12-19 - 5:55:41 PM GMT - Time Source: server- Signature captured from device with phone number XXXXXXX2079
-  Document emailed to Yamil Rivera (yamil.rivera@lumapr.com) for signature  
2024-12-19 - 5:55:43 PM GMT
-  Email viewed by Yamil Rivera (yamil.rivera@lumapr.com)  
2024-12-19 - 5:56:23 PM GMT
-  Document e-signed by Yamil Rivera (yamil.rivera@lumapr.com)  
Signature Date: 2024-12-19 - 5:57:01 PM GMT - Time Source: server
-  Agreement completed.  
2024-12-19 - 5:57:01 PM GMT