



**Wedge Connector  
Installation Tool**

**Equipment Specification**

Document No.: 4752.219

Item No.: 086-81964

Originating Dept: Transmission Eng.

	Document Title: <b>Wedge Connector Installation Tool</b>		
	Document Type: <b>Equipment Specification</b>	Document No.: <b>4752.219</b>	
Department: Transmission Engineering	Version: 01	Issue Date: 5/30/2022	Effective Date: 5/30/2022

<p><b>Author</b> Emmanuel E Rivera Cruz Designer, Transmission &amp; Substation Engineering</p> <p><b>Reviewer 1</b> Rene Maldonado Supervisor, Line Engineering Standards</p> <p><b>Reviewer 2</b> Oscar Venegas Lead Engineer, Trans</p> <p><b>Approver</b> Walter Carrasquillo Alberty Manager, T&amp;S Standards and Materials</p>	Signature and Date  <u>Emmanuel E Rivera Cruz (Jun 6, 2022 11:46 EDT)</u>
	Signature and Date  <u>Rene Maldonado (Jun 6, 2022 11:51 EDT)</u>
	Signature and Date  <u>Oscar E Venegas (Jun 13, 2022 17:12 EDT)</u>
	Signature and Date  <u>Walter Carrasquillo (Jun 14, 2022 12:46 EDT)</u>

<b>Management Approval</b>	
<p>Heriberto González Section Manager, Standards</p> <p>Darrel Wilvers Director, Asset Management</p>	Signature and Date  <u>Heriberto Gonzalez (Jun 14, 2022 22:44 EDT)</u>
	Signature and Date  <b>N/A</b>

<b>Version History</b>					
Version	Date	Revision Comments	Author	Reviewers	Approver
00	July 12, 2021		Rene Maldonado	Heriberto Gonzalez	Walter Carrasquillo
01	May 30, 2022	General revision for final approval	Emmanuel E. Rivera	Rene Maldonado Oscar Venegas	Walter Carrasquillo



## **1. General**

- 1.1. This specification describes the minimum requirements of wedge connector installation tool.
- 1.2. The wedge connector shall be designed, rated, manufactured, and tested in accordance with the latest applicable IEEE, NEMA, ANSI, ASTM, and NEC Standards<sup>1</sup>, If the Vendor does not demonstrate its compliance with the applicable standards, these specification requirements and supply the requested documents, the bid may be rejected.
- 1.3. The Vendor shall provide LUMA Energy with a list of recommended spare parts, tools, and service equipment, including prices.

## **2. Specific Name**

- 2.1. Installation tool "pistol" for wedge connector ( Run & Tap ) for ACSR conductors

## **3. Basic Use**

- 3.1. For a secure connection of ACSR conductors at dead structures in distribution lines.

## **4. Special Requirements**

- 4.1. Samples shall be furnished if requested by LUMA.
- 4.2. LUMA may required one (1) unit properly labeled for testing and analysis.
- 4.3. Descriptive and technical literature shall be supplied if requested by LUMA.
- 4.4. Vendors that have supplied this material to PREPA in previous orders, will not have to furnish samples at bid opening.
- 4.5. They shall be required to show evidence of LUMA's approval of the equipment if requested.

## **5. Marking and packaging**

- 5.1. Containers shall be marked outside with LUMA's purchase order number and code number.
- 5.2. Vendor shall prepare material and equipment for shipment in such a manner as to facilitate handling and protection from damage.

All material shall be packaged and marked in such a way that the receiving warehouse can readily identify and send in one (1) complete unit to a field location without opening crates or boxes to sort items and/or parts.

---

<sup>1</sup> IEEE = Institute of Electrical and Electronics Engineers  
NEMA = National Electric Manufacturers Association  
ANSI = American National Standard Institute  
ASTM = American Society of Testing and Materials  
NEC = National Electric Code.



## **6. Labeling**

- 6.1. Each unit shall be clearly marked with the installation tool to be used, either with a color coding or numbering.

## **7. Equal or approved equal to:**

- 7.1. Burndy Corp., Catalog number – Type - WTRBYK
- 7.2. Ampact Tool – AMPS-0-1443414-1 Large

## **8. Number of pieces per package:**

- 8.1. Each kit includes hot stick power unit, large and small for different power boosters, cleaning kit and molded carrying case.

## **9. Description**

- 9.1. Installation tool is a one piece assembly that consists of a head and power unit. Two color coded interchangeable heads accept all wedge connectors.

## **10. Inspection**

- 10.1. The acceptance of any material or equipment shall in no way relieve the vendor from his responsibility to meet all the requirements of this specification, and it shall not prevent subsequent rejection if such material is found to be defective later.



11. Drawing

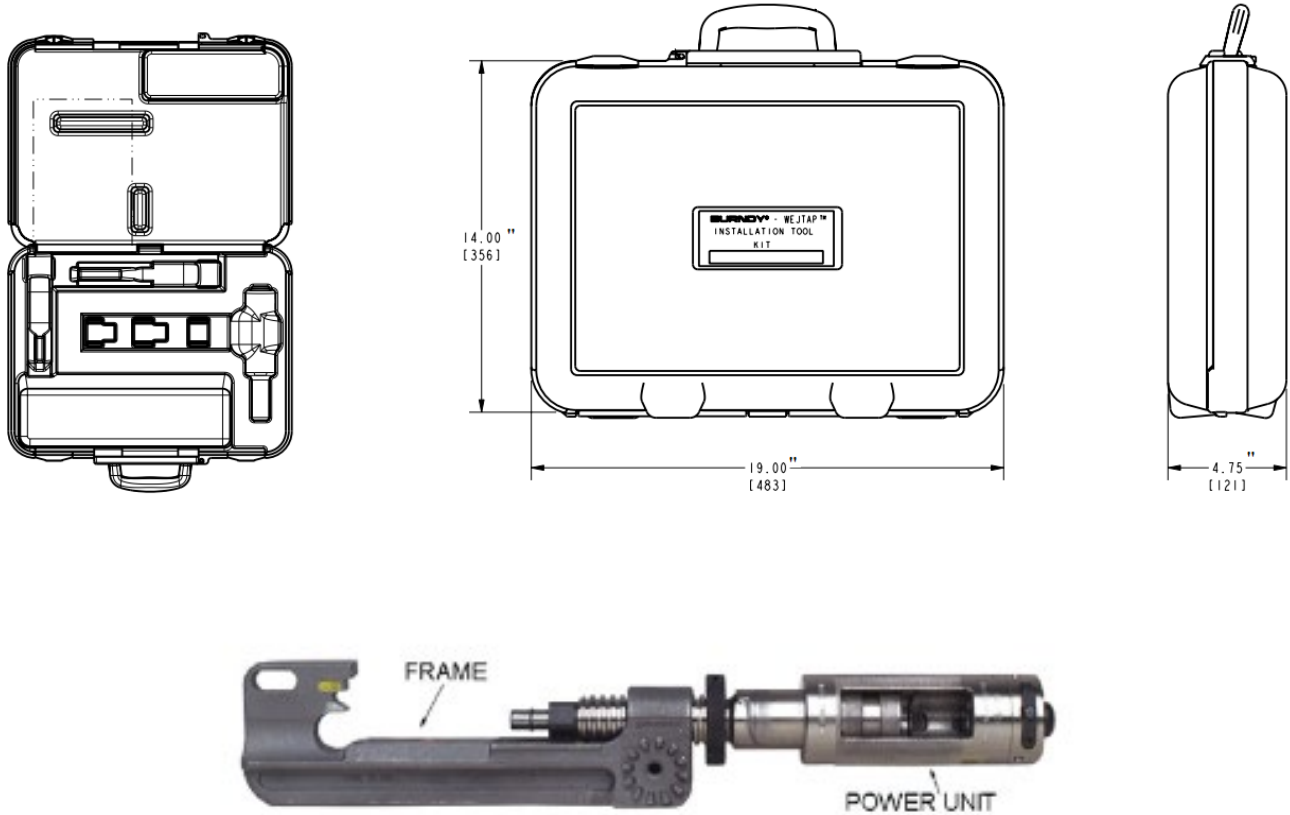

— End of Specification —











# 4752.219 Wedge Instalation Tool

Final Audit Report

2022-06-15

Created:	2022-06-06
By:	Emmanuel E Rivera Cruz (emmanuel.riveracruz@lumapr.com)
Status:	Signed
Transaction ID:	CBJCHBCAABAAaqFxtaLeod3XF_6ZY384hwIPUM7zlaGI

## "4752.219 Wedge Instalation Tool" History

-  Document created by Emmanuel E Rivera Cruz (emmanuel.riveracruz@lumapr.com)  
2022-06-06 - 3:44:36 PM GMT
-  Document e-signed by Emmanuel E Rivera Cruz (emmanuel.riveracruz@lumapr.com)  
Signature Date: 2022-06-06 - 3:46:10 PM GMT - Time Source: server
-  Document emailed to Rene Maldonado (rene.maldonado@lumapr.com) for signature  
2022-06-06 - 3:46:12 PM GMT
-  Email viewed by Rene Maldonado (rene.maldonado@lumapr.com)  
2022-06-06 - 3:46:17 PM GMT
-  Document e-signed by Rene Maldonado (rene.maldonado@lumapr.com)  
Signature Date: 2022-06-06 - 3:51:03 PM GMT - Time Source: server
-  Document emailed to Oscar E Venegas (oscar.venegas@lumapr.com) for signature  
2022-06-06 - 3:51:05 PM GMT
-  Email viewed by Oscar E Venegas (oscar.venegas@lumapr.com)  
2022-06-06 - 3:51:09 PM GMT
-  Email viewed by Oscar E Venegas (oscar.venegas@lumapr.com)  
2022-06-11 - 3:55:47 PM GMT
-  Email viewed by Oscar E Venegas (oscar.venegas@lumapr.com)  
2022-06-12 - 3:55:42 PM GMT
-  Email viewed by Oscar E Venegas (oscar.venegas@lumapr.com)  
2022-06-13 - 3:55:46 PM GMT
-  Document e-signed by Oscar E Venegas (oscar.venegas@lumapr.com)  
Signature Date: 2022-06-13 - 9:12:03 PM GMT - Time Source: server- Signature captured from device with phone number XXXXXXXX2079

 Document emailed to Walter Carrasquillo (walter.carrasquillo@lumapr.com) for signature

2022-06-13 - 9:12:05 PM GMT

 Email viewed by Walter Carrasquillo (walter.carrasquillo@lumapr.com)

2022-06-13 - 9:12:10 PM GMT

 Document e-signed by Walter Carrasquillo (walter.carrasquillo@lumapr.com)

Signature Date: 2022-06-14 - 4:46:27 PM GMT - Time Source: server

 Document emailed to Heriberto Gonzalez (heriberto.gonzalez@lumapr.com) for signature

2022-06-14 - 4:46:29 PM GMT

 Email viewed by Heriberto Gonzalez (heriberto.gonzalez@lumapr.com)

2022-06-14 - 4:46:34 PM GMT

 Document e-signed by Heriberto Gonzalez (heriberto.gonzalez@lumapr.com)

E-signature obtained using URL retrieved through the Adobe Acrobat Sign API

Signature Date: 2022-06-15 - 2:44:42 AM GMT - Time Source: server

 Agreement completed.

2022-06-15 - 2:44:42 AM GMT