



Detachable Step Bolt for Steel Pole

Equipment Specification

Document No.: 4752.210

Item No.: 086-12814

Originating Dept: Transmission Eng.



Document Title:

Detachable Step Bolt for Steel Pole

Document Type:

Equipment Specification

Document No.:

4752.210

Department:

Transmission Engineering

Version:

01

Issue Date:

5/25/2022

Effective Date:

5/25/2022

Author

Emmanuel E Rivera Cruz

Designer, Transmission & Substation Engineering

Signature and Date

Emmanuel E Rivera Cruz (Jun 2, 2022 11:42 EDT)

Reviewer 1

Rene Maldonado

Supervisor, Line Engineering Standards

Signature and Date

Rene Maldonado (Jun 3, 2022 10:04 EDT)

Reviewer 2

Oscar Venegas

Lead Engineer, Trans

Signature and Date

Oscar E Venegas (Jun 9, 2022 11:09 EDT)

Approver

Walter Carrasquillo Alberty

Manager, T&S Standards and Materials

Signature and Date

Walter Carrasquillo (Jun 10, 2022 08:25 EDT)

Management Approval

Heriberto González

Section Manager, Standards

Signature and Date

Heriberto Gonzalez (Jun 10, 2022 09:38 EDT)

Darrel Wilvers

Director, Asset Management

Signature and Date

N/A

Version History

| Version | Date | Revision Comments | Author | Reviewers | Approver |
|---------|--------------|-------------------------------------|--------------------|---------------------------------|---------------------|
| 00 | Dec 28, 2021 | | Rene Maldonado | Heriberto Gonzalez | Walter Carrasquillo |
| 01 | May 25, 2022 | General revision for final approval | Emmanuel E. Rivera | Rene Maldonado Oscar Venegas | Walter Carrasquillo |
| | | | | | |
| | | | | | |



1. General

- 1.1. This is a general specification that covers the minimum requirements for a Detachable Step Bolt for Steel Pole used in the distribution and transmission system in Puerto Rico.
- 1.2. Further information will be provided by LUMA Energy at the time of order placement and will provide information on site conditions, quantity, and other requirements.
- 1.3. This document includes the general electrical and mechanical characteristics of the material.

2. Specific Name:

- 2.1. Detachable Step Bolt for Steel Pole.

3. Basic Use

- 3.1. To be used with the bolt & plate as a climbing device in 70S8, 85S8 and 95S13 galvanized steel poles.

4. Special Requirements

- 4.1. Samples shall be furnished if requested by LUMA.
- 4.2. LUMA may require One (1) units properly labeled for testing and analysis.
- 4.3. Descriptive and technical literature shall be supplied if requested by LUMA.

5. Marking and Packaging

- 5.1. Containers/pallets or package shall be marked outside with LUMA'S purchase order number and code number. Vendor shall prepare material and equipment for shipment in such manner as to facilitate handling and protection for damage. All material should be packaged and marked in such a way that the receiving warehouse can readily identify and send in one (1) complete unit to a field location without opening crates or boxes to sort items and / or parts.

6. Equal or approved equal to:

- 6.1. Hubbell Chance Catalog No. PS6236.

7. Number of Pieces per package

- 7.1. Standard package quantity: 60 units or as requested by LUMA.

8. Acceptance Criteria

- 8.1. Latest applicable codes, standards, and other regulations: ANSI/ASTM A153.

9. Description

- 9.1. Detachable pole step to be used in conjunction with a bolt and plate on steel poles as a climbing device.
- 9.2. Step removal deters unauthorized pole climbing and makes a clean appearance.



- 9.3. Used with bolt & plate assembly Catalog No. T2050433 by Hubbell/Chance (Warehouse Code: 086-12889), for metal poles.
- 9.4. This step shall be made of hot dip galvanized steel and shall be 5 3/8 inches long approximately.
- 9.5. Shall have an open slot at one end to fit the lag in the pole.
- 9.6. Metric conversion as per latest ASTM.

10. Inspection

- 10.1. The acceptance of any material or equipment shall in no way relieve the vendor from his responsibility to meet all the requirements of this specification, and it shall not prevent subsequent rejection if such material is found to be defective later.

11. Typical Drawing:

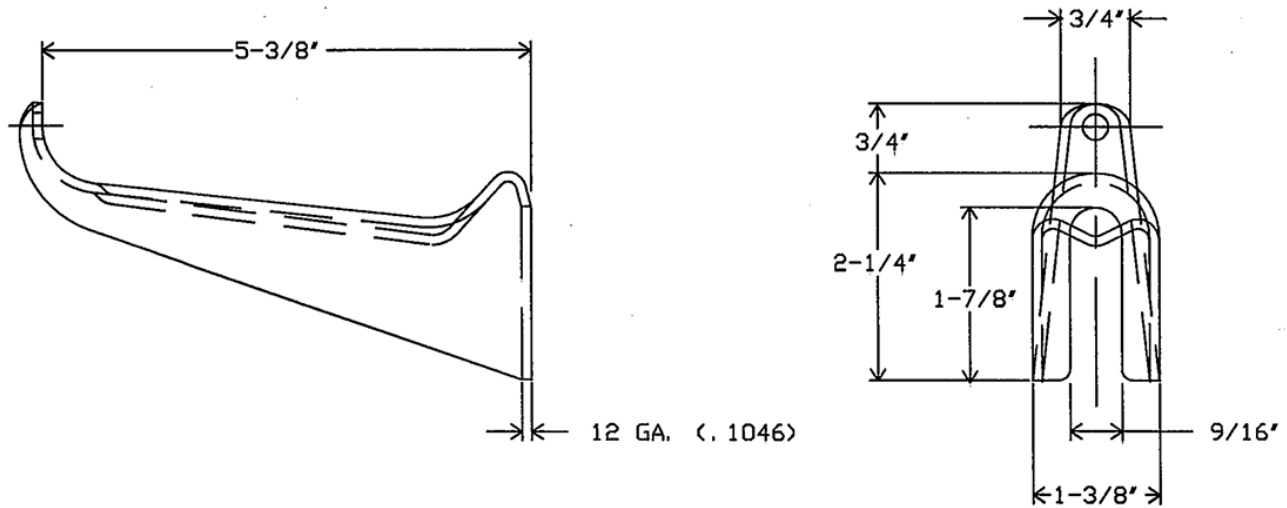

– End of Specification –











4752.210 Detachable Step Bolt for Steel Pole

Final Audit Report

2022-06-10

| | |
|-----------------|---|
| Created: | 2022-06-02 |
| By: | Emmanuel E Rivera Cruz (emmanuel.riveracruz@lumapr.com) |
| Status: | Signed |
| Transaction ID: | CBJCHBCAABAAzl_mLBlznKUVYCAkwWFxjhCBSkZJhaq1 |

"4752.210 Detachable Step Bolt for Steel Pole" History

-  Document created by Emmanuel E Rivera Cruz (emmanuel.riveracruz@lumapr.com)
2022-06-02 - 3:40:45 PM GMT
-  Document e-signed by Emmanuel E Rivera Cruz (emmanuel.riveracruz@lumapr.com)
Signature Date: 2022-06-02 - 3:42:25 PM GMT - Time Source: server
-  Document emailed to Rene Maldonado (rene.maldonado@lumapr.com) for signature
2022-06-02 - 3:42:27 PM GMT
-  Email viewed by Rene Maldonado (rene.maldonado@lumapr.com)
2022-06-02 - 3:42:31 PM GMT
-  Document e-signed by Rene Maldonado (rene.maldonado@lumapr.com)
Signature Date: 2022-06-03 - 2:04:45 PM GMT - Time Source: server
-  Document emailed to Oscar E Venegas (oscar.venegas@lumapr.com) for signature
2022-06-03 - 2:04:48 PM GMT
-  Email viewed by Oscar E Venegas (oscar.venegas@lumapr.com)
2022-06-03 - 2:04:51 PM GMT
-  Email viewed by Oscar E Venegas (oscar.venegas@lumapr.com)
2022-06-09 - 3:02:46 PM GMT
-  Document e-signed by Oscar E Venegas (oscar.venegas@lumapr.com)
Signature Date: 2022-06-09 - 3:09:06 PM GMT - Time Source: server- Signature captured from device with phone number XXXXXXXX2079
-  Document emailed to Walter Carrasquillo (walter.carrasquillo@lumapr.com) for signature
2022-06-09 - 3:09:08 PM GMT
-  Email viewed by Walter Carrasquillo (walter.carrasquillo@lumapr.com)
2022-06-10 - 12:24:16 PM GMT

 Document e-signed by Walter Carrasquillo (walter.carrasquillo@lumapr.com)

Signature Date: 2022-06-10 - 12:25:10 PM GMT - Time Source: server

 Document emailed to Heriberto Gonzalez (heriberto.gonzalez@lumapr.com) for signature

2022-06-10 - 12:25:11 PM GMT

 Document e-signed by Heriberto Gonzalez (heriberto.gonzalez@lumapr.com)

E-signature obtained using URL retrieved through the Adobe Acrobat Sign API

Signature Date: 2022-06-10 - 1:38:53 PM GMT - Time Source: server

 Agreement completed.

2022-06-10 - 1:38:53 PM GMT