



Suspension Socket Clamp
556.5 ACSR/ACSS

Equipment Specification

Document No.: 4752.180

Item No.: 002-13918

Originating Dept: Transmission Eng.

	Document Title: Suspension Socket Clamp 556.5 ACSR/ACSS		
	Document Type: Equipment Specification	Document No.: 4752.180	
Department: Transmission Engineering	Version: 01	Issue Date: 5/17/2022	Effective Date: 5/17/2022

<p>Author Emmanuel E Rivera Cruz Designer, Transmission & Substation Engineering</p> <p>Reviewer 1 Rene Maldonado Supervisor, Line Engineering Standards</p> <p>Reviewer 2 Oscar Venegas Lead Engineer, Trans</p> <p>Approver Walter Carrasquillo Alberty Manager, T&S Standards and Materials</p>	Signature and Date Emmanuel E Rivera Cruz (Jun 2, 2022 11:39 EDT)
	Signature and Date Rene Maldonado (Jun 3, 2022 10:04 EDT)
	Signature and Date Oscar E Venegas (Jun 9, 2022 11:00 EDT)
	Signature and Date Walter Carrasquillo (Jun 10, 2022 08:27 EDT)

Management Approval

<p>Heriberto González Section Manager, Standards</p> <p>Darrel Wilvers Director, Asset Management</p>	Signature and Date Heriberto Gonzalez (Jun 10, 2022 09:39 EDT)
	Signature and Date N/A

Version History

Version	Date	Revision Comments	Author	Reviewers	Approver
00	Dec 28, 2021		Rene Maldonado	Heriberto Gonzalez	Walter Carrasquillo
01	May 17, 2022	General revision for final approval	Emmanuel E. Rivera	Rene Maldonado Oscar Venegas	Walter Carrasquillo



1. General

- 1.1. This is a general specification that covers the minimum requirements for a Suspension Socket Clamp for 556.5 ACSR and ACSS 24/7 Parakeet, with preformed straight or tapered armor rods, used in the transmission system in Puerto Rico.
- 1.2. Further information will be provided by LUMA Energy at the time of order placement and will provide information on site conditions, quantity, and other requirements.
- 1.3. This document includes the general electrical and mechanical characteristics of the material.

2. Specific Name:

- 2.1. Suspension Socket Clamp 556.5 ACSR/ACSS.

3. Basic Use

- 3.1. Aluminum suspension clamps is used to affix the 556.5 ACSR/ACSS, with preformed straight or tapered armor rods on transmission lines structures.

4. Special Requirements

- 4.1. Samples shall be furnished if requested by LUMA.
- 4.2. LUMA may require One (1) units properly labeled for testing and analysis.
- 4.3. Descriptive and technical literature shall be supplied if requested by LUMA.

5. Marking and Packaging

- 5.1. Containers/pallets or package shall be marked outside with LUMA'S purchase order number and code number. Vendor shall prepare material and equipment for shipment in such manner as to facilitate handling and protection for damage. All material should be packaged and marked in such a way that the receiving warehouse can readily identify and send in one (1) complete unit to a field location without opening crates or boxes to sort items and / or parts.

6. Equal or approved equal to:

- 6.1. Hubbell. Catalog ID: HAS139S

7. Number of Pieces per package

- 7.1. Pallet quantity: 240, or as requested by LUMA.

8. Acceptance Criteria

- 8.1. Latest applicable codes, standards, and other regulations: ANSI/ASTM A153.

9. Description

- 9.1. Aluminum suspension clamps shall be made with an ultimate strength of 25,000 lbf minimum.
- 9.2. Suspension clamp hardware shall be hot-dip galvanized in accordance with ANSI/ASTM A153.

9.3. Body and keeper: heat-treated, high strength, cast aluminum alloy.

9.4. Metric conversion as per latest ASTM.

10. Inspection

10.1. The acceptance of any material or equipment shall in no way relieve the vendor from his responsibility to meet all the requirements of this specification, and it shall not prevent subsequent rejection if such material is found to be defective later.

11. Typical Drawing:

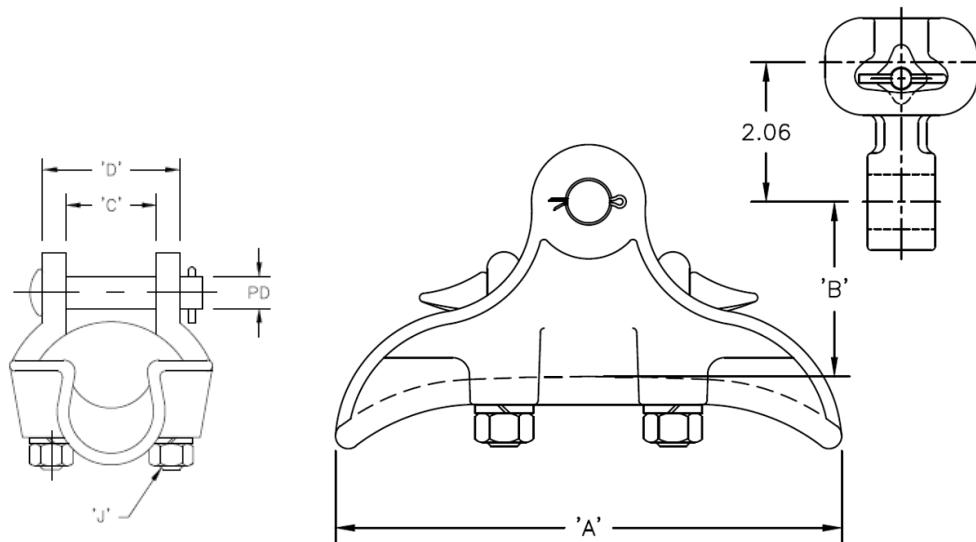

Clamp Range	A Min.	B Min	C Min	D Min.	J Dia	PD Min.
0.90" – 1.39"	8.88"	3.00"	1.62"	2.56"	0.50"	0.63"

– End of Specification –

4752.180 Suspension Socket Clamp 556.5 ACSR

Final Audit Report

2022-06-10

Created:	2022-06-02
By:	Emmanuel E Rivera Cruz (emmanuel.riveracruz@lumapr.com)
Status:	Signed
Transaction ID:	CBJCHBCAABAAZ6JXe_-b_lci3BUS4oc74TseoelYV_pY

"4752.180 Suspension Socket Clamp 556.5 ACSR" History

 Document created by Emmanuel E Rivera Cruz (emmanuel.riveracruz@lumapr.com)
2022-06-02 - 3:37:48 PM GMT

 Document e-signed by Emmanuel E Rivera Cruz (emmanuel.riveracruz@lumapr.com)
Signature Date: 2022-06-02 - 3:39:08 PM GMT - Time Source: server

 Document emailed to Rene Maldonado (rene.maldonado@lumapr.com) for signature
2022-06-02 - 3:39:10 PM GMT

 Email viewed by Rene Maldonado (rene.maldonado@lumapr.com)
2022-06-02 - 3:39:15 PM GMT

 Document e-signed by Rene Maldonado (rene.maldonado@lumapr.com)
Signature Date: 2022-06-03 - 2:04:34 PM GMT - Time Source: server

 Document emailed to Oscar E Venegas (oscar.venegas@lumapr.com) for signature
2022-06-03 - 2:04:37 PM GMT

 Email viewed by Oscar E Venegas (oscar.venegas@lumapr.com)
2022-06-03 - 2:04:42 PM GMT

 Email viewed by Oscar E Venegas (oscar.venegas@lumapr.com)
2022-06-05 - 2:08:04 PM GMT

 Email viewed by Oscar E Venegas (oscar.venegas@lumapr.com)
2022-06-08 - 2:08:12 PM GMT

 Email viewed by Oscar E Venegas (oscar.venegas@lumapr.com)
2022-06-09 - 2:08:04 PM GMT

-  Document e-signed by Oscar E Venegas (oscar.venegas@lumapr.com)
Signature Date: 2022-06-09 - 3:00:38 PM GMT - Time Source: server- Signature captured from device with phone number XXXXXXXX2079

-  Document emailed to Walter Carrasquillo (walter.carrasquillo@lumapr.com) for signature
2022-06-09 - 3:00:40 PM GMT

-  Email viewed by Walter Carrasquillo (walter.carrasquillo@lumapr.com)
2022-06-09 - 3:00:44 PM GMT

-  Document e-signed by Walter Carrasquillo (walter.carrasquillo@lumapr.com)
Signature Date: 2022-06-10 - 12:27:57 PM GMT - Time Source: server

-  Document emailed to Heriberto Gonzalez (heriberto.gonzalez@lumapr.com) for signature
2022-06-10 - 12:27:59 PM GMT

-  Email viewed by Heriberto Gonzalez (heriberto.gonzalez@lumapr.com)
2022-06-10 - 12:28:03 PM GMT

-  Document e-signed by Heriberto Gonzalez (heriberto.gonzalez@lumapr.com)
E-signature obtained using URL retrieved through the Adobe Acrobat Sign API
Signature Date: 2022-06-10 - 1:39:13 PM GMT - Time Source: server

-  Agreement completed.
2022-06-10 - 1:39:13 PM GMT